

XXVII. Rury i kształtki kanalizacyjne:



XXVII.1. Rury i kształtki PP :

System kanalizacji wewnętrznej Valsir wykonany jest zgodnie z normami UNI8319, UNI8320, oraz DIN19560.

Posiada certyfikat zgodności z wymogami normy UNI EN ISO 9002. Wszystkie rury i kształtki wyposażone są w elastomerowe uszczelki o podwójnej wardze z pierścieniem utrzymującym. System kanalizacji wewn. z PP Valsir posiada Aprobataę Techniczną COBRTI INSTAL AT/99-02-0605-01.

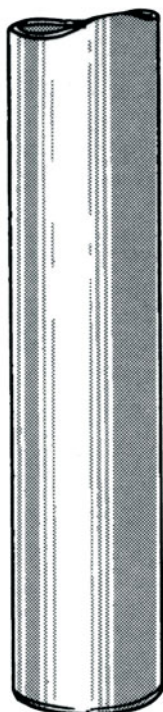
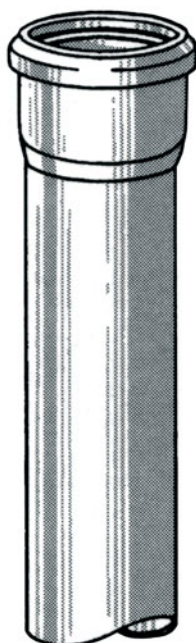

kod	rury PP (śred/długość)	szt w opak.	cena netto	cena brutto
10.500.001	32/150	30	1.37 zł	1.67 zł
10.500.003	32/250	30	1.46 zł	1.78 zł
10.500.004	32/315	30	1.60 zł	1.95 zł
10.500.005	32/500	30	2.07 zł	2.52 zł
10.500.007	32/750	30	2.95 zł	3.60 zł
10.500.009	32/1000	30	3.81 zł	4.65 zł
10.500.011	32/1500	30	5.25 zł	6.41 zł
10.500.013	32/2000	30	6.56 zł	8.00 zł
10.500.015	32/3000	30	10.21 zł	12.46 zł
10.500.021	40/150	30	1.60 zł	1.96 zł
10.500.023	40/250	30	2.00 zł	2.44 zł
10.500.024	40/315	30	2.37 zł	2.89 zł
10.500.025	40/500	30	2.83 zł	3.45 zł
10.500.027	40/750	30	4.19 zł	5.11 zł
10.500.029	40/1000	30	4.75 zł	5.79 zł
10.500.031	40/1500	30	6.73 zł	8.22 zł
10.500.033	40/2000	30	7.89 zł	9.63 zł
10.500.035	40/3000	30	11.29 zł	13.77 zł
10.500.041	50/150	30	1.47 zł	1.80 zł
10.500.043	50/250	30	1.63 zł	1.99 zł
10.500.044	50/315	30	1.90 zł	2.32 zł
10.500.045	50/500	30	2.41 zł	2.94 zł
10.500.047	50/750	30	3.70 zł	4.52 zł
10.500.049	50/1000	30	4.12 zł	5.02 zł
10.500.051	50/1500	30	6.52 zł	7.95 zł
10.500.053	50/2000	30	8.42 zł	10.27 zł
10.500.055	50/3000	30	12.11 zł	14.78 zł
10.500.061	75/150	20	2.23 zł	2.72 zł
10.500.063	75/250	20	2.71 zł	3.30 zł
10.500.065	75/500	20	4.19 zł	5.11 zł
10.500.067	75/750	25	5.92 zł	7.23 zł
10.500.069	75/1000	25	7.20 zł	8.78 zł
10.500.071	75/1500	25	10.19 zł	12.44 zł
10.500.073	75/2000	25	13.57 zł	16.56 zł
10.500.075	75/3000	25	19.12 zł	23.32 zł
10.500.081	110/150	15	3.56 zł	4.34 zł
10.500.083	110/250	15	4.68 zł	5.70 zł
10.500.084	110/315	15	5.35 zł	6.52 zł
10.500.085	110/500	15	6.98 zł	8.51 zł
10.500.087	110/750	15	10.06 zł	12.27 zł
10.500.089	110/1000	15	11.62 zł	14.18 zł
10.500.091	110/1500	15	18.40 zł	22.45 zł
10.500.093	110/2000	15	19.81 zł	24.17 zł
10.500.095	110/3000	15	34.30 zł	41.85 zł
10.500.097	110/4000	15	44.56 zł	54.36 zł
10.500.098	110/6000	15	64.08 zł	78.18 zł
10.500.121	160/150	10	9.93 zł	12.11 zł
10.500.123	160/250	10	9.93 zł	12.11 zł
10.500.125	160/500	10	15.21 zł	18.56 zł
10.500.129	160/1000	10	26.31 zł	32.10 zł
10.500.131	160/1500	10	36.42 zł	44.43 zł
10.500.133	160/2000	10	46.80 zł	57.09 zł
10.500.135	160/3000	10	77.91 zł	95.05 zł

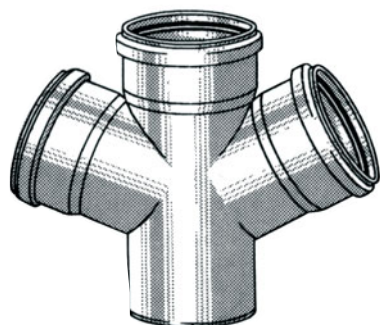

kod	kolano PP (sr./kąt)	szt w opak.	cena netto	cena brutto
10.504.001	32/15	50	2.28 zł	2.78 zł
10.504.003	32/30	50	2.28 zł	2.78 zł
10.504.005	32/45	50	2.28 zł	2.78 zł
10.504.007	32/67	50	2.28 zł	2.78 zł
10.504.009	32/80	50	2.46 zł	3.00 zł
10.504.011	32/87	50	2.28 zł	2.78 zł
10.504.013	40/15	20	1.86 zł	2.27 zł
10.504.015	40/30	20	1.86 zł	2.27 zł
10.504.017	40/45	20	1.86 zł	2.27 zł
10.504.019	40/67	20	1.86 zł	2.27 zł
10.504.021	40/80	20	1.86 zł	2.27 zł
10.504.023	40/87	20	1.86 zł	2.27 zł
10.504.025	50/15	20	2.04 zł	2.49 zł
10.504.027	50/30	20	1.82 zł	2.23 zł
10.504.029	50/45	20	1.82 zł	2.23 zł
10.504.031	50/67	20	1.82 zł	2.23 zł
10.504.033	50/80	20	2.46 zł	3.00 zł
10.504.035	50/87	20	1.82 zł	2.23 zł
10.504.037	75/15	20	4.05 zł	4.94 zł
10.504.039	75/30	20	4.05 zł	4.94 zł
10.504.041	75/45	20	4.05 zł	4.94 zł
10.504.043	75/67	20	4.05 zł	4.94 zł
10.504.045	75/80	20	4.05 zł	4.94 zł
10.504.047	75/87	20	4.05 zł	4.94 zł
10.504.049	110/15	20	5.74 zł	7.00 zł
10.504.051	110/30	20	4.61 zł	5.62 zł
10.504.053	110/45	20	4.61 zł	5.62 zł
10.504.055	110/67	20	4.75 zł	5.79 zł
10.504.057	110/80	20	7.14 zł	8.72 zł
10.504.059	110/87	20	4.75 zł	5.79 zł
10.504.073	*160/15		42.96 zł	52.42 zł
10.504.075	*160/30		42.96 zł	52.42 zł
10.504.077	*160/45		42.96 zł	52.42 zł
10.504.083	*160/87		51.91 zł	63.33 zł

kod	czwórnik	szt w opak.	cena netto	cena brutto
10.506.001	50/50/67	20	26.48 zł	32.31 zł
10.506.005	*75/75/67	10	30.29 zł	36.95 zł
10.506.009	*110/50/67	10	26.48 zł	32.31 zł
10.506.011	*110/50/87	10	26.48 zł	32.31 zł
10.506.013	*110/110/67	5	37.77 zł	46.08 zł
10.506.015	*110/110/87	5	37.77 zł	46.08 zł

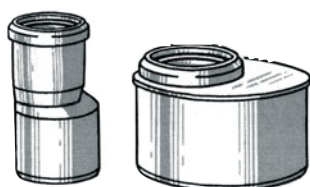
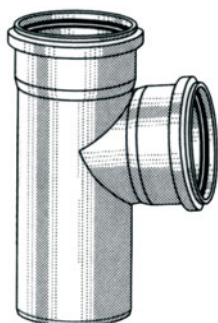
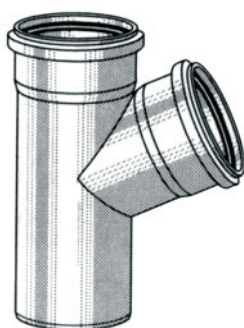
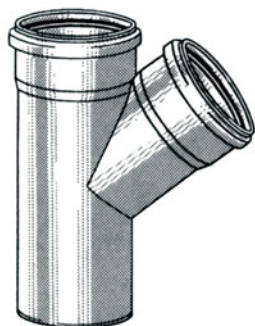

kod	trójnik kątowy	szt w opak.	cena netto	cena brutto
10.508.001	32/32/45	40	4.20 zł	5.13 zł
10.508.003	32/32/67	40	4.20 zł	5.13 zł
10.508.005	32/32/87	40	4.20 zł	5.13 zł
10.508.007	40/40/45	20	3.30 zł	4.03 zł
10.508.009	40/40/67	20	3.30 zł	4.03 zł
10.508.011	40/40/87	20	3.30 zł	4.03 zł
10.508.013	50/50/45	20	4.57 zł	5.58 zł
10.508.015	50/50/67	20	4.57 zł	5.58 zł
10.508.017	50/50/87	20	4.57 zł	5.58 zł
10.508.019	75/75/45	20	5.91 zł	7.21 zł
10.508.021	75/75/67	20	5.91 zł	7.21 zł
10.508.023	75/75/87	20	5.91 zł	7.21 zł
10.510.019	75/50/45	20	5.39 zł	6.58 zł
10.510.021	75/50/67	20	5.39 zł	6.58 zł
10.510.023	75/50/87	20	5.39 zł	6.58 zł
10.508.025	110/110/45	20	7.90 zł	9.63 zł
10.508.027	110/110/67	20	7.90 zł	9.63 zł
10.508.029	110/110/87	20	7.90 zł	9.63 zł
10.510.031	110/50/45	20	6.35 zł	7.74 zł
10.510.033	110/50/67	20	6.35 zł	7.74 zł
10.510.035	110/50/87	20	6.35 zł	7.74 zł
10.510.037	110/75/45	20	12.78 zł	15.59 zł
10.510.039	110/75/67	20	7.37 zł	9.00 zł
10.510.041	110/75/87	20	7.37 zł	9.00 zł
10.508.037	*160/160/45	5	187.61 zł	228.89 zł
10.508.039	*160/160/67	5	187.61 zł	228.89 zł
10.508.041	*160/160/87	5	187.61 zł	228.89 zł
10.510.061	*160/110/45	5	121.73 zł	148.51 zł
10.510.063	*160/110/67	5	121.73 zł	148.51 zł
10.510.065	*160/110/87	5	121.73 zł	148.51 zł

kod	redukcje	szt w opak.	cena netto	cena brutto
10.514.001	40/32	30	3.12 zł	3.81 zł
10.514.002	50/32	20	3.41 zł	4.16 zł
10.514.003	50/40	50	1.98 zł	2.41 zł
10.514.005	75/40	20	4.78 zł	5.83 zł
10.514.007	75/50	20	4.01 zł	4.89 zł
10.514.009	110/50	20	3.34 zł	4.08 zł
10.514.011	110/75	20	6.79 zł	8.28 zł
10.514.017	160/110	20	29.47 zł	35.96 zł

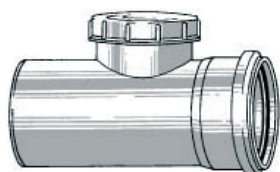

kod	rewizje	szt w opak.	cena netto	cena brutto
10.516.003	50	20	8.19 zł	9.99 zł
10.516.005	75	20	9.01 zł	10.99 zł
10.516.007	110	20	10.84 zł	13.22 zł
10.516.011	*160	5	109.34 zł	133.39 zł



kod	korki	szt w opak.	cena netto	cena brutto
10.524.001	40	20	1.10 zł	1.34 zł
10.524.003	50	20	1.37 zł	1.67 zł
10.524.005	75	20	1.84 zł	2.25 zł
10.524.007	110	20	2.35 zł	2.87 zł
10.524.011	*160	10	23.41 zł	28.55 zł

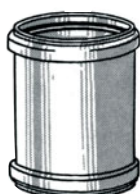

kod	mufy	szt w opak.	cena netto	cena brutto
10.528.000	32	40	3.83 zł	4.67 zł
10.528.001	40	20	2.75 zł	3.35 zł
10.528.003	50	20	3.60 zł	4.40 zł
10.526.005	75	20	5.08 zł	6.20 zł
10.526.007	110	20	8.47 zł	10.33 zł
10.526.011	*160	10	41.22 zł	50.29 zł
10.626.005	160 orange	10	11.60 zł	14.15 zł

kod	złączka PCV-żeliwo	szt w opak.	cena netto	cena brutto
10.569.001	50	20	8.47 zł	10.33 zł
10.569.003	*75	20	10.35 zł	12.62 zł
10.569.005	110	20	16.24 zł	19.81 zł



kod	preparat smarujący	szt w opak.	cena netto	cena brutto
10.900.001	150 g	50	6.05 zł	7.38 zł
10.900.003	250g		7.26 zł	8.86 zł



kod	wywiewki z dasz.	szt.w opak.	cena netto	cena brutto
10.392.001	wywiewka 50		9.56 zł	11.67 zł
10.392.003	wywiewka 75		10.14 zł	12.37 zł
10.392.005	wywiewka 110		14.31 zł	17.46 zł

kod	wywiewki "DES"	cena netto	cena brutto
37.110.050	wywiewka 50	6.00 zł	7.32 zł
37.110.075	wywiewka 75	6.00 zł	7.32 zł
37.111.110	wywiewka 110	7.00 zł	8.54 zł
37.111.160	wywiewka 160	14.00 zł	17.08 zł



kod	napowietrzacze "DES"	cena netto	cena brutto
37.112.050	napowietrzacz 50	6.00 zł	7.32 zł
37.113.075	napowietrzacz 75	10.00 zł	12.20 zł
37.114.110	napowietrzacz 110	12.00 zł	14.64 zł

**Dostępny również system kanalizacji niskoszumowej SILERE
w/g katalogu Valsir Polska.**

XXVII.2. Rury i kształtki PCV (kan.zewn.) :



System kanalizacji zewn. z PCV-U (twarde) ValsirPolska posiada Aprobatę Techniczną COBRTI INSTAL AT/2001-02-1131 (rury) i AT/99-02-0678 (złączki).

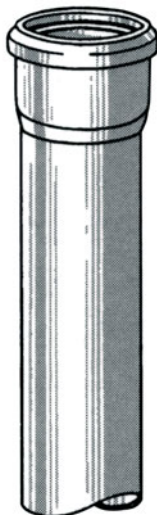

kod	rury PCV-U (śred/grub/długość) kolor orange	cena netto	cena brutto
10.605.002	*110/3,2/500 typ ciężki	8.20 zł	10.00 zł
10.605.003	*110/3,2/1000 typ ciężki	14.20 zł	17.32 zł
10.605.004	*110/3,2/2000 typ ciężki	26.00 zł	31.72 zł
10.605.005	*110/3,2/3000 typ ciężki	38.00 zł	46.36 zł
10.605.008	*110/3,2/6000 typ ciężki	74.00 zł	90.28 zł
10.602.022	*160/3,2/500 typ lekki	11.70 zł	14.27 zł
10.602.023	160/3,2/1000 typ lekki	20.40 zł	24.89 zł
10.602.024	160/3,2/2000 typ lekki	36.70 zł	44.77 zł
10.602.025	*160/3,2/3000 typ lekki	53.00 zł	64.66 zł
10.602.028	*160/3,2/6000 typ lekki	102.00 zł	124.44 zł
10.603.023	*160/4,0/1000 typ średni	24.10 zł	29.54 zł
10.603.024	*160/4,0/2000 typ średni	43.85 zł	53.49 zł
10.603.025	*160/4,0/3000 typ średni	63.50 zł	77.47 zł
10.603.028	*160/4,0/6000 typ średni	123.00 zł	150.06 zł
10.605.023	*160/4,7/1000 typ ciężki	29.00 zł	35.38 zł
10.605.024	*160/4,7/2000 typ ciężki	53.00 zł	64.66 zł
10.605.025	*160/4,7/3000 typ ciężki	77.00 zł	93.94 zł
10.605.028	*160/4,7/6000 typ ciężki	150.00 zł	182.98 zł
10.603.034	200/4,9/2000	45.00 zł	54.90 zł
10.603.036	200/4,9/4000	85.00 zł	103.70 zł
10.603.037	200/4,9/5000	105.00 zł	128.10 zł
10.603.038	200/4,9/6000	129.00 zł	157.38 zł



kod	kolano PCV-U (sr./kąt) kolor orange	cena netto	cena brutto
10.604.001	*110/15	5.70 zł	6.95 zł
10.604.003	*110/30	6.15 zł	7.50 zł
10.604.005	*110/45	6.87 zł	8.38 zł
10.604.007	*110/67	9.15 zł	11.16 zł
10.604.009	*110/87	9.75 zł	11.90 zł
10.604.021	*160/15	11.40 zł	13.91 zł
10.604.023	*160/30	13.40 zł	16.35 zł
10.604.025	*160/45	13.95 zł	17.02 zł
10.604.027	160/67	16.20 zł	19.76 zł
10.604.029	160/87	18.90 zł	23.06 zł

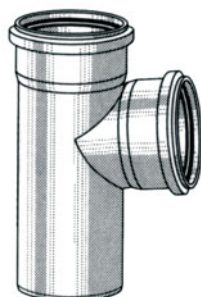

kod	PCV-U kolor orange	cena netto	cena brutto
10.608.025	*trójnik 160/160/45	35.00 zł	42.70 zł
10.608.029	*trójnik 160/160/87	32.00 zł	39.04 zł
10.610.420	*trójnik 160/110/45	22.90 zł	27.94 zł
10.610.820	*trójnik 160/110/87	22.90 zł	27.94 zł
10.624.005	*korek 160	7.20 zł	8.78 zł
10.616.005	*rewizja 160	121.00 zł	147.62 zł
10.626.005	mufa 160	11.60 zł	14.15 zł
10.614.003	redukcja 160/110	10.00 zł	12.20 zł

Dostępne również większe średnice do 500mm w/g katalogu Valsir Polska.

XXVIII.1. Systemy mocowań :



kod	uchw.podw.z koł.	szt. w op.	cena netto	cena brutto
37.101.015	uchwyt fi 15	50	0.36 zł	0.44 zł
37.101.018	uchwyt fi 18	50	0.40 zł	0.49 zł
37.101.022	uchwyt fi 22	50	0.47 zł	0.57 zł
37.101.028	uchwyt fi 28	50	0.60 zł	0.73 zł

kod	uchw.poj.z koł.	szt. w op.	cena netto	cena brutto
37.102.015	uchwyt fi 15	50	0.25 zł	0.31 zł
37.102.018	uchwyt fi 18	50	0.32 zł	0.39 zł
37.102.022	uchwyt fi 22	50	0.34 zł	0.41 zł
37.102.028	uchwyt fi 28	50	0.44 zł	0.54 zł

kod	obejmy tworzą kolory biały	szt.w op.	cena netto	cena brutto
37.125.032.X	obejma 32		0.70 zł	0.85 zł
37.123.050.X	obejma 50		0.95 zł	1.16 zł
37.121.110.X	obejma 110		1.35 zł	1.65 zł

kod	rozetki	szt. w op.	cena netto	cena brutto
37.106.0XX.X	fi 12-28	50	0.40 zł	0.49 zł
37.106.050	fi 50 biała		1.00 zł	1.22 zł
37.106.110	fi 110 biała		3.00 zł	3.66 zł

kod		cena netto	cena brutto
43.102.310.1010	wspornik wymiennika uniw.140-160	45.00 zł	54.90 zł
43.102.310.1110	wspornik naczyń wyrównawczego	28.60 zł	34.89 zł

XXVIII.2. Uchwyty metalowe Gorgiel :



kod	uchw.poj.zwykłe	szt. w op.	cena netto	cena brutto
43.103.111.6110	uchwyt do rur 10 3/8	50	1.75 zł	2.14 zł
43.UPZ.1823	uchwyt do rur 15 1/2 18-23	50	1.53 zł	1.87 zł
43.UPZ.2428	uchwyt do rur 20 3/4 24-28	50	1.74 zł	2.12 zł
43.UPZ.3237	uchwyt do rur 25 1" 32-37	50	1.80 zł	2.20 zł
43.UPZ.3846	uchwyt do rur 32 5/4 38-46	50	1.89 zł	2.31 zł
43.UPZ.4754	uchwyt do rur 40 6/4 47-54	50	1.96 zł	2.39 zł
43.UPZ.5462	uchwyt do rur 50 2" 54-62	25	2.11 zł	2.57 zł
43.103.111.6170	*uchwyt do rur 75 2.5"	30	3.30 zł	4.03 zł
43.103.111.6180	*uchwyt do rur 80 3"	30	3.99 zł	4.87 zł
43.103.111.6190	*uchwyt do rur 100 4"	20	4.40 zł	5.37 zł
43.103.111.6200	*uchwyt do rur 125 5"	10	5.04 zł	6.15 zł
43.103.111.6210	*uchwyt do rur 150 6"	10	5.62 zł	6.86 zł
43.103.111.6220	*uchwyt do rur 200 8"	5	17.94 zł	21.89 zł



kod	uchw.poj.z gumą	szt. w op.	cena netto	cena brutto
43.UPG.1217	uchwyt 10 3/8 12-17	50	1.65 zł	2.01 zł
43.UPG.1822	uchwyt 15 1/2 18-22	50	1.82 zł	2.22 zł
43.UPG.2631	uchwyt 20 3/4 26-31	50	1.92 zł	2.34 zł
43.UPG.3240	uchwyt 25 1" 32-40	50	2.05 zł	2.50 zł
43.UPG.4148	uchwyt 32 5/4 41-48	50	2.19 zł	2.67 zł
43.UPG.4856	uchwyt 40 6/4 48-56	50	2.36 zł	2.88 zł
43.103.112.6160	uchwyt 50 2"	50	3.20 zł	3.90 zł
43.103.112.6170	*uchwyt 75 2.5"	30	4.19 zł	5.11 zł
43.103.112.6180	*uchwyt 80 3"	30	4.77 zł	5.82 zł
43.103.112.6190	*uchwyt 100 4"	20	5.82 zł	7.10 zł
43.103.112.6200	*uchwyt 125 5"	10	6.86 zł	8.37 zł
43.103.112.6210	*uchwyt 150 6"	10	7.01 zł	8.55 zł
43.103.112.6220	*uchwyt 200 8"	5	21.07 zł	25.71 zł



kod	uchw.podw.zwykłe	szt. w op.	cena netto	cena brutto
43.103.121.6020	uchwyt 1/2	50	3.27 zł	3.99 zł
43.103.121.6030	uchwyt 3/4	50	3.71 zł	4.53 zł
43.103.121.6040	uchwyt 1"	50	4.39 zł	5.36 zł



kod	uchw.podw.z gumą	szt. w op.	cena netto	cena brutto
43.103.122.6010	uchwyt 10 3/8	50	4.13 zł	5.04 zł
43.103.122.6020	uchwyt 15 1/2	50	4.62 zł	5.64 zł
43.103.122.6030	uchwyt 20 3/4	50	4.85 zł	5.92 zł
43.103.122.6040	uchwyt 25 1"	50	5.52 zł	6.73 zł